

BEFORE THE INDUSTRIAL COMMISSION
OF THE STATE OF NORTH DAKOTA

CASE NO. 25973
ORDER NO. 28386

IN THE MATTER OF A HEARING CALLED ON A MOTION OF THE COMMISSION TO CONSIDER THE APPLICATION OF SM ENERGY CO. PURSUANT TO NDAC § 43-02-03-88.1 FOR AN ORDER ALLOWING OIL AND GAS PRODUCED FROM THE HAGEN 3-28HN (FILE NO. 30703), SECTIONS 16 AND 21, T.160N., R.99W., AND HAGEN 3-28HS (FILE NO. 30702), SECTIONS 28 AND 33, T.160N., R.99W., DIVIDE COUNTY, ND, WELLS TO BE COMMINGLED IN A CENTRAL PRODUCTION FACILITY LOCATED IN SECTION 28, T.160N., R.99W., PURSUANT TO NDAC § 43-02-03-48.1 OR GRANTING SUCH OTHER AND FURTHER RELIEF AS MAY BE APPROPRIATE.

ORDER OF THE COMMISSION

THE COMMISSION FINDS:

- (1) This cause came on for hearing at 9:00 a.m. on the 26th day of July, 2017.
- (2) Pursuant to North Dakota Administrative Code (NDAC) Section 43-02-03-88.1, the Director is authorized to sign, on behalf of the Commission, orders relating to, inter alia, commingling of production from two or more wells in a central tank battery under NDAC Section 43-02-03-48.1.
- (3) SM Energy Company (SM Energy) is the operator of the following wells in the Burg Field, Divide County, North Dakota:

<u>File No.</u>	<u>Well Name & No.</u>	<u>Location</u>
30702	Hagen 3-28HS	NENW Section 28-T160N-R99W
30703	Hagen 3-28HN	NENW Section 28-T160N-R99W

- (4) SM Energy requests permission to commingle the production from the wells listed in paragraph (3) in the Hagen 3-28 CTB (CTB No. 230702-01) located in the NE/4 NW/4 of Section 28, Township 160 North, Range 99 West, Divide County, North Dakota, pursuant to

NDAC Section 43-02-03-48.1. There are no wells currently authorized to be commingled in the Hagen 3-28 Central Tank Battery.

(5) SM Energy submitted a Sundry Notice and attachments for approval pursuant to NDAC Section 43-02-03-88.1 and NDAC Section 43-02-03-48.1.

(6) SM Energy states that the ownership in the wells listed in paragraph (3) above is diverse.

(7) SM Energy will allocate production measured at the central production facility to the various wells on the basis of production tests utilizing the facilities at the central production facility. The production from each well will be separately measured each month and applicant believes that such allocation will result in a reasonably accurate determination of production from each well.

(8) NDAC Section 43-02-03-48 states: "Oil production may not be transported from a well premises, central production facility, treating plant, or saltwater handling facility until its volume has been determined through the use of properly calibrated meter measurements or tank measurements. All meter and tank measurements, and volume determinations must conform to American petroleum institute standards and be corrected to a base temperature of sixty degrees Fahrenheit [15.56 degrees Celsius] and fourteen and seventy-three hundredths pounds per square inch absolute [1034.19 grams per square centimeter]."

(9) Allowing such commingling will reduce the expenditure of funds on surface facilities and enhance the economics of production, thereby preventing economic waste and promoting the greatest ultimate recovery of oil and gas from the Burg Field. Utilization of central production facilities will minimize surface disturbance and promote both full utilization of the surface and enhance the aesthetic values resulting from fewer production facilities.

(10) SM Energy will construct and operate the central production facility in such a manner that allows for reasonably accurate allocation of production to each respective party.

(11) The proposed process, measurement, and allocation will result in a reasonably accurate determination of production.

(12) There were no objections to this application.

(13) The granting of this application will prevent waste and protect correlative rights.

IT IS THEREFORE ORDERED:

(1) SM Energy Company, its assigns and successors, is hereby permitted to commingle production from the wells listed in paragraph (3) below into the Hagen 3-28 CTB (CTB No. 230702-01) located in the NE/4 NW/4 of Section 28, Township 160 North, Range 99 West, Divide County, North Dakota, pursuant to NDAC Section 43-02-03-48.1.

(2) Allocation tests shall be performed monthly.

(3) The following wells are authorized to be commingled in the Hagen 3-28 CTB:

<u>File No.</u>	<u>Well Name & No.</u>	<u>Location</u>	<u>Order No.</u>
30702	Hagen 3-28HS	NENW Section 28-T160N-R99W	28386
30703	Hagen 3-28HN	NENW Section 28-T160N-R99W	28386

(4) The permission granted herein is conditioned upon SM Energy receiving approval of the Sundry Notice and attachments submitted and complying with all provisions dictated by the Director for permission to commingle production from the wells listed in paragraph (3) above into the Hagen 3-28 CTB.

(5) SM Energy shall use the following procedures for allocating production to each well commingled in the Hagen 3-28 CTB:

- (a) Production from each well shall be isolated to allow production to stabilize before commingling can begin.
- (b) Each well shall be tested a minimum of three consecutive days per month.
- (c) The exact producing time, between the opening and closing inventory, shall be considered when determining the average well test rate for each well.
- (d) Each well's tests shall be averaged for the month.
- (e) Downtime shall be monitored to determine the exact total number of producing hours for each well.
- (f) A monthly production volume shall be calculated for each well as follows:

$$\text{Calculated oil volume} = (\text{Average well test oil rate}) * (\text{Number of producing hours}).$$

$$\text{Calculated gas volume} = (\text{Average well test gas rate}) * (\text{Number of producing hours}).$$

$$\text{Calculated water volume} = (\text{Average well test water rate}) * (\text{Number of producing hours}).$$

- (g) The calculated monthly production volumes shall be totaled for all the wells producing into the central production facility to determine the total calculated monthly volumes for the central production facility.
- (h) A correction factor shall be calculated by dividing the total actual monthly production volumes for the central production facility by the total calculated monthly production volumes for the central production facility.

- (i) Each well's allocated production shall then be calculated by multiplying its individual calculated oil, gas, and water volumes by the correction factor calculated in step (h).
- (6) If gas is sold from the central production facility, the gas volumes must be accurately allocated back to the individual wells.
- (7) The Director is hereby authorized to issue an administrative order modifying any provision of this order in order to prevent waste or protect correlative rights or to modify any procedures for testing or allocation of production herein approved if it can be demonstrated to his satisfaction that production from a new well has stabilized and/or that a reasonably accurate allocation of production to each separate well producing into the facility will be obtained.
- (8) Additional wells can only be added to the Hagen 3-28 CTB by order of the Commission after due notice and hearing.
- (9) The results of each well's test and other data needed to determine the allocation for each well shall be filed with the Director at the same time monthly oil production reports are filed.
- (10) SM Energy shall notify the Director in writing upon commencement of commingling production from the subject wells into the central production facility.
- (11) Authorization to commingle is transferable only with approval of the Director.
- (12) The Director is hereby authorized to rescind this order if SM Energy, its assigns or successors, fails to comply with any of the above provisions.
- (13) This order shall remain in full force and effect until further order of the Commission.

Dated this 10th day of August, 2017.

INDUSTRIAL COMMISSION
STATE OF NORTH DAKOTA

By the Director, on behalf of the Commission

/s/ Lynn D. Helms, Director

SFN 5729

STATE OF NORTH DAKOTA

AFFIDAVIT OF MAILING

COUNTY OF BURLEIGH

I, Jeanette Bean, being duly sworn upon oath, depose and say: That on the 15th day of August, 2017 enclosed in separate envelopes true and correct copies of the attached Order No. 28386 of the North Dakota Industrial Commission, and deposited the same with the United States Postal Service in Bismarck, North Dakota, with postage thereon fully paid, directed to the following persons by the Industrial Commission in Case No. 25973:

CROWLEY FLECK PLLP
PO BOX 2798
BISMARCK ND 58502

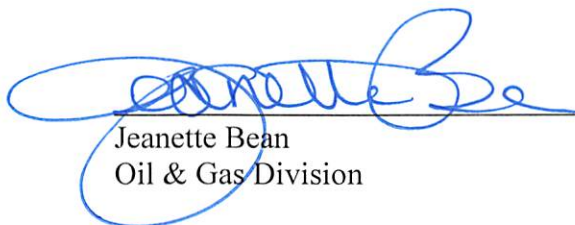

Jeanette Bean
Oil & Gas Division

On this 15th day of August, 2017 before me personally appeared Jeanette Bean to me known as the person described in and who executed the foregoing instrument and acknowledged that she executed the same as her free act and deed.

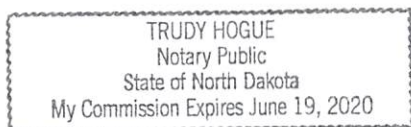

Trudy Hogue
Notary Public
State of North Dakota, County of Burleigh

Kadrmass, Bethany R.

From: Lisa Herberholz <lherberholz@crowleyfleck.com>
Sent: Tuesday, July 25, 2017 4:35 PM
To: Hicks, Bruce E.
Cc: Whitney Lott; Kadrmass, Bethany R.; John W. Morrison
Subject: SM Energy Commingling Affidavits & Exhibits - Part 5
Attachments: SM - Balcer Commingling Aff 25972.pdf; SM - Case 25972 Exhibits.pdf; SM - Balcer Commingling Aff 25973.pdf; SM - Case 25973 Exhibits.pdf; SM - Balcer Commingling Aff 25974.pdf; SM - Case 25974 Exhibits.pdf; SM - Balcer Commingling Aff 25975.pdf; SM - Case 25975 Exhibits.pdf

CAUTION: This email originated from an outside source. Do not click links or open attachments unless you know they are safe.

Part 5

CROWLEY | FLECK^{PLLP}
ATTORNEYS

Lisa Herberholz

Administrative Assistant
Crowley Fleck PLLP
100 West Broadway Avenue, Suite 250
P.O. Box 2798
Bismarck, ND 58502
Direct 701.224.7538
Fax 701.222.4853
✉ lherberholz@crowleyfleck.com

Notice: This electronic mail transmission may constitute an attorney-client communication that is privileged at law. It is not intended for transmission to, or receipt by, any unauthorized persons. If you have received this electronic mail transmission in error, please delete it from your system without copying it, and notify the sender by reply e-mail or by calling Crowley Fleck PLLP, so that our address record can be corrected.

NOTICE: THIS ELECTRONIC MAIL TRANSMISSION MAY CONSTITUTE AN ATTORNEY-CLIENT COMMUNICATION THAT IS PRIVILEGED AT LAW. IT IS NOT INTENDED FOR TRANSMISSION TO, OR RECEIPT BY, ANY UNAUTHORIZED PERSONS. IF YOU HAVE RECEIVED THIS ELECTRONIC MAIL TRANSMISSION IN ERROR, PLEASE DELETE IT FROM YOUR SYSTEM WITHOUT COPYING IT, AND NOTIFY THE SENDER BY REPLY E-MAIL OR BY CALLING CROWLEY FLECK PLLP AT 406-252-3441, SO THAT OUR ADDRESS RECORD CAN BE CORRECTED.

This email has been scanned for email related threats and delivered safely by Mimecast. For more information please visit <http://www.mimecast.com>

John W. Morrison
100 West Broadway, Suite 250
P.O. Box 2798
Bismarck, ND 58502-2798
Office: 701.223.6585
Direct: 701.224.7534
jmorrison@crowleyfleck.com

July 25, 2017

Via Electronic Mail

Mr. Bruce Hicks
Oil & Gas Division
ND INDUSTRIAL COMMISSION
600 E. Blvd. Ave., Dept. 405
Bismarck, ND 58505-0840

In re: SM Energy Co.
Case Nos. 25949-25975

Dear Mr. Hicks:

Please find enclosed the affidavits of Bobby Balcer and exhibits in these cases. We request that these matters be decided on the basis of the affidavits.

If you need any further information, please let me know.

Sincerely,

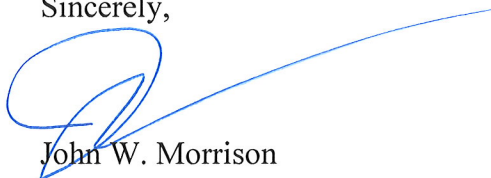

John W. Morrison

lh
enc.

cc (via e-mail): Whitney Lott
Bethany Kadrmas

BEFORE THE INDUSTRIAL COMMISSION
OF THE STATE OF NORTH DAKOTA

Application of SM Energy Co. pursuant to)
NDAC §43-02-03-88.1 for an order allowing)
oil and gas produced from the Hagen 3-28HN)
(File No. 30703), Sections 16 and 21,)
T.160N., R.99W., and Hagen 3-28HS (File)
No. 30702), Sections 28 and 33, T.160N.,)
R.99W., Divide County, ND, wells to be)
commingled in a central production facility)
located in Section 28, T.160N., R.99W.,)
pursuant to NDAC § 43-02-03-48.1 or)
granting such other and further relief as is)
appropriate.)

Case No. 25973

AFFIDAVIT OF BOBBY BALCER

STATE OF COLORADO)
)SS.
COUNTY OF DENVER)

Bobby Balcer, being duly sworn, states as follows:

1. I am employed by SM Energy Company as the Production Engineering Manager and my telephone number is (303) 837-2421. I have personal knowledge of the matters set forth in this affidavit. I have a BS in Petroleum Engineering from Montana Tech, an accredited program. I have worked in the industry since June 2005, holding several operational engineering and supervisor roles.

2. I prepared or supervised the preparation of the exhibits in Case No. 25973.

3. To the best of my knowledge, the exhibits in Case No. 25973 are true and correct.

Dated this 25th day of July, 2017.



Bobby Balcer

STATE OF COLORADO)
)SS.
COUNTY OF DENVER)

Subscribed to and sworn before me this 25th day of July, 2017.

Celesta Jean Worley
Notary Public

State of Colorado

My Commission Expires: 1-13-2020

(SEAL)

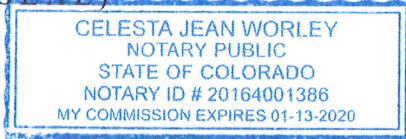



SM Energy Company

Facility: Hagen 3-28 CTB

Case No: 25973

Hearing Date: July 26, 2017

Enclosed:

- Sundry notices and reports on wells Form 4
- Notice of transfer of oil and gas wells
- Maps showing the location of the wells to be commingled, flowlines, and the central facility
- Process flow diagram (PFD) of the central facility showing fluid flow, separation, metering, transfer, and storage
- Description of meters to be used at the central facility
- Explanation of allocation produces



SUNDRY NOTICES AND REPORTS ON WELLS - FORM 4

INDUSTRIAL COMMISSION OF NORTH DAKOTA
OIL AND GAS DIVISION
600 EAST BOULEVARD DEPT 405
BISMARCK, ND 58505-0840
SFN 5749 (09-2006)

Well File No.
30703-01

PLEASE READ INSTRUCTIONS BEFORE FILLING OUT FORM.
PLEASE SUBMIT THE ORIGINAL AND ONE COPY.

<input checked="" type="checkbox"/> Notice of Intent	Approximate Start Date May 1, 2017
<input type="checkbox"/> Report of Work Done	Date Work Completed
<input type="checkbox"/> Notice of Intent to Begin a Workover Project that may Qualify for a Tax Exemption Pursuant to NDCC Section 57-51.1-03.	Approximate Start Date

<input type="checkbox"/> Drilling Prognosis	<input type="checkbox"/> Spill Report
<input type="checkbox"/> Redrilling or Repair	<input type="checkbox"/> Shooting
<input type="checkbox"/> Casing or Liner	<input type="checkbox"/> Acidizing
<input type="checkbox"/> Plug Well	<input type="checkbox"/> Fracture Treatment
<input type="checkbox"/> Supplemental History	<input type="checkbox"/> Change Production Method
<input type="checkbox"/> Temporarily Abandon	<input type="checkbox"/> Reclamation
<input checked="" type="checkbox"/> Other	Commingling Request - Recycle Lines

Well Name and Number Hagen 3-28 CTB					
Footages	Qtr-Qtr	Section	Township	Range	
330 F N L 2275 F W L	NENW	28	160 N	99 W	
Field Burg	Pool Bakken	County Divide			

24-HOUR PRODUCTION RATE			
Before		After	
Oil	Bbls	Oil	Bbls
Water	Bbls	Water	Bbls
Gas	MCF	Gas	MCF

Name of Contractor(s)			
Address	City	State	Zip Code

DETAILS OF WORK

SM Energy Company requests permission to commingle production (specifically shared recycle pump/lines) from the Hagen 3-28HN (NDIC# 30703) and Hagen 3-28HS (NDIC# 30702) at the Hagen 3-28 Central Tank Battery (CTB#30703-01). This CTB has been built to accommodate production from 2 total wells. Produced emulsion from each well will be independently flowlined to a dedicated 6' x 20' 125 psi heater treater, four independent 400-bbl production oil tanks, an independent total produced gas meter and two shared water tanks per well. Immediately prior to oil sales by truck, oil will be measured downstream at each production tank. Gas will be sold at independent custody transfer meters before tying into a larger gas gathering line. Water from each well will be stored in produced water tanks and transferred to offsite disposal via pipeline.

The following information is attached:

1. Maps showing the location of the wells to be commingled, flowlines, and the central facility
2. Process flow diagram (PFD) of the central facility
3. Description of meters to be used at the central facility
4. Explanation of allocation procedures

Company SM Energy Company	Telephone Number (303) 861-8140
Address 1775 Sherman St. Suite 1200	
City Denver	State CO
	Zip Code 80203
Signature 	Printed Name Austin Johnsrud
Title Production Engineer	Date May 1, 2017
Email Address ajohnsrud@sm-energy.com	

FOR STATE USE ONLY	
<input type="checkbox"/> Received	<input type="checkbox"/> Approved
Date	
By	
Title	

1.

SM ENERGY COMPANY
HAGEN 3-28HN
330' FNL & 2275' FWL

NW1/4 Section 28, T160N, R99W - 5th Principal Meridian
Divide County, North Dakota

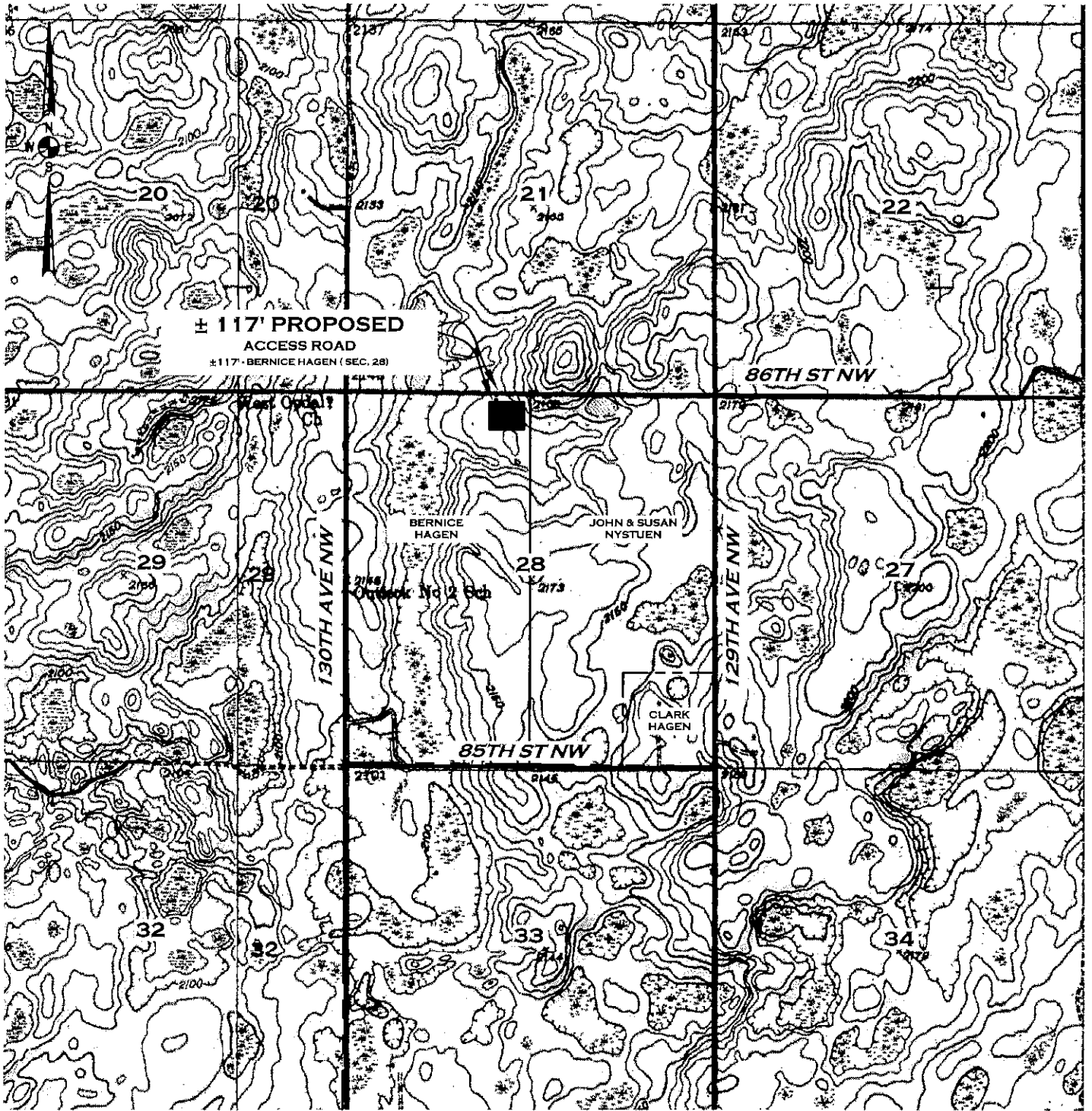

319 24th Street East
 Dickinson, ND 58601
 701.483.2444 office
 701.483.2610 fax
 www.highlandseng.com

LEGEND

PROPOSED ROAD - - - - -
 EXISTING ROAD ————

SHEET NAME: QUAD ACCESS	DATE: 11/25/14	DRAWN BY: TRA	SCALE: 1"=2000'	PROJ. NO. 146535	SHEET NO. 5 of 6
----------------------------	-------------------	------------------	--------------------	---------------------	---------------------

WELL LOCATION PLAT

SM ENERGY COMPANY

550 NORTH 31ST STREET BILLINGS, MT 59101

HAGEN 3-28HN

330 feet from the north line and 2275 feet from the west line

Section 28, T160N, R99W - 5th Principal Meridian

Divide County, North Dakota

Surface Owner at well site - Bernice Hagen

Latitude 48°39'42.19" (48.661719°) North -

Longitude 103°29'04.72" (103.484643°) West

[derived from N.G.S. O.P.U.S. Solution REF FRAME

NAD_83 (CORS96)(EPOCH:2002.0000)]



Scale 1"=1800'

I, James D. Glasser, Registered Land Surveyor, N.D. No. 5771, do hereby certify that the well plat shown hereon was made by me, or under my direction, and is true and correct to the the best of my knowledge and belief.

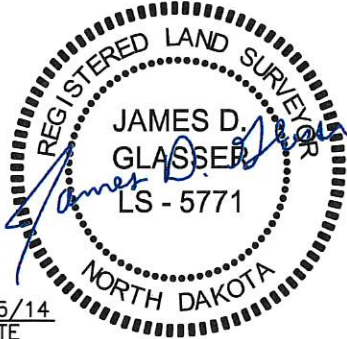

11/25/14
DATE

NOTE: All land corners are assumed unless otherwise noted. Location shown hereon is a preliminary staked location and is not an as-built.

JAMES D. GLASSER

11/14/14

Surveyed by N.D.R.L.S. #5771

Date

Vertical Control Datum Used
Sea-Level Datum of NAVD 88

Based on elevation derived from OPUS Solution on GPS Base Station (Base) in the NW $\frac{1}{4}$ NW $\frac{1}{4}$ of Section 28, T161N, R98W, 5th P.M. located N89°58'20"W a distance of 5289.08' from the northeast corner of said Section 28 being at 2019.34' Elevation MSL.

**HIGHLANDS
ENGINEERING &
SURVEYING, PLLC**

319 24th Street East
Dickinson, ND 58601

701.483.2444 office

701.483.2610 fax

www.highlandseng.com

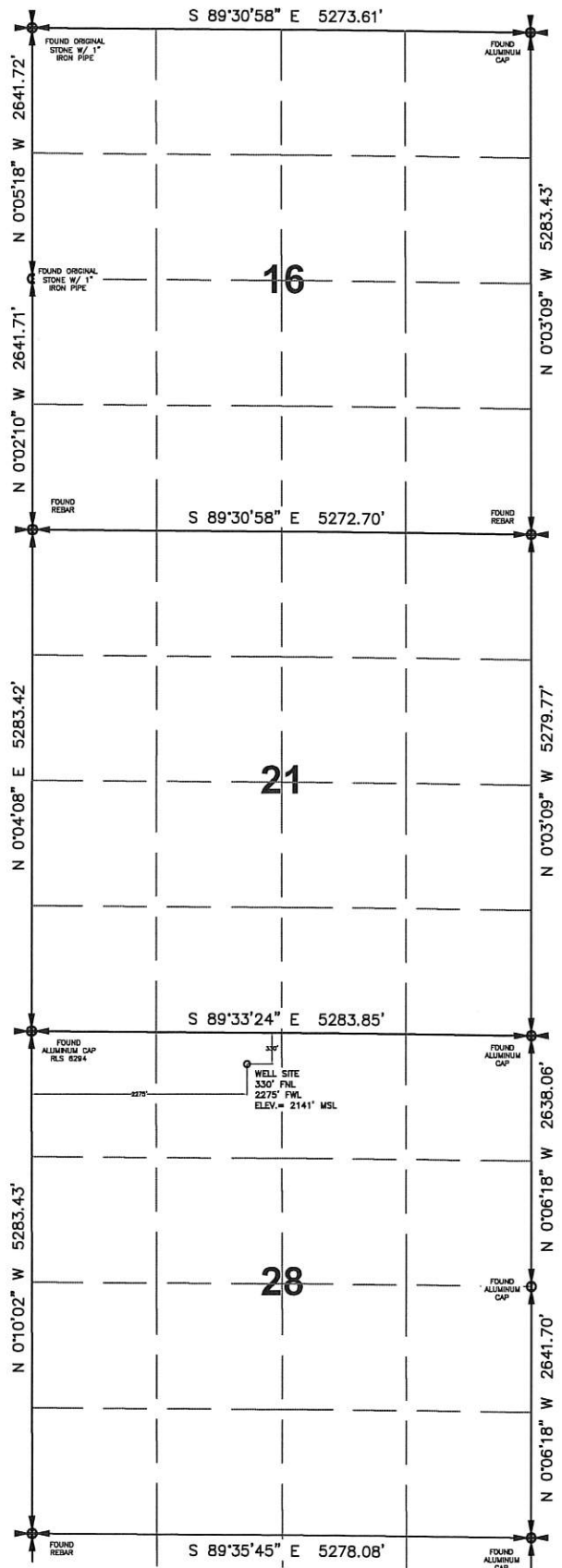

PROJECT NO. 146535

**SM ENERGY COMPANY
HAGEN 3-28HN
330' FNL & 2275' FWL**

NW1/4 Section 28, T160N, R99W - 5th Principal Meridian
Divide County, North Dakota

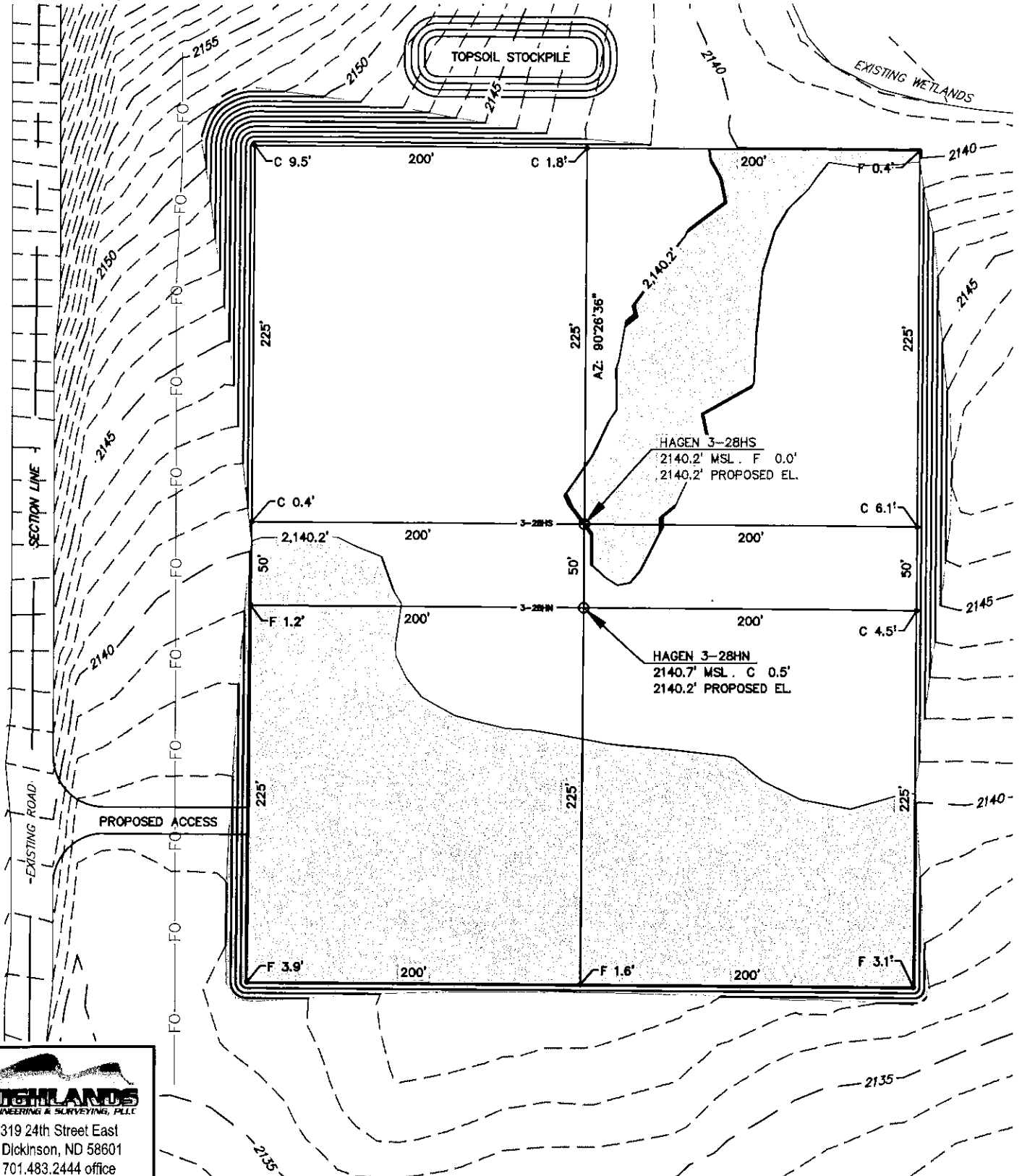

HIGHLANDS
ENGINEERING & SURVEYING, PLLC

319 24th Street East
Dickinson, ND 58601
701.483.2444 office
701.483.2610 fax
www.highlandseng.com

SHEET NAME: PAD LAYOUT	DATE: 11/25/14	DRAWN BY: TRA	SCALE: 1"=80'	PROJ. NO. 146535	SHEET NO. 2 of 6
---------------------------	-------------------	------------------	------------------	---------------------	---------------------

Hagen 3-28 Central Tank Battery
 (Full Buildout)
 Divide Co., ND
 SM Energy

TTRT - 1 (two) - 2

Vertical Treater
 Manufacturer: Shell's, Inc.
 Model VTR20-FEP-125
 6' dia.
 20' H (x-A)
 Working Pressure = 125 psig
 Capacity @ 1 hr. retention:
 1000 bpd oil
 3000 bpd water
 2-3 x 10⁶ m³/d gas

FI2 (two) FIS

Orifice Plate Meter
 ASA 14.3 - compliant
 meter tube w/
 Cameron NuFlo
 Scanner 2000 totalizer

FI2 (two) FIS

Gas Meter - by others
 ABB TotalFlow Orifice (or equivalent)
 Custody transfer - specified & operated
 by gas gatherer

FI10 (two) FI11

Water Meter
 NuFlo Turbine meter 2"
 MC-III Display

FT10 (two) FT11

Oil Meter
 Emerson MicroMotion
 Coriolis Meter
 F200 (2")
 w/ transmitter

FLARE - 1

Elevated Flame stack
 Manufacturer: Staffes
 Dual-Tip Burner
 Low/High Press. Combustion

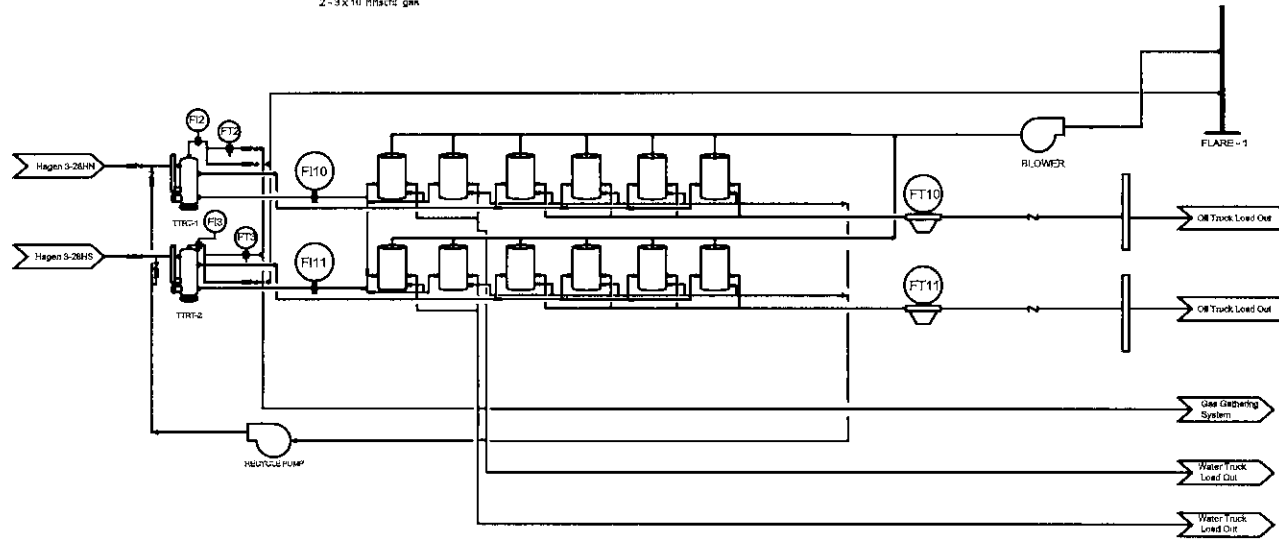

3. **Hagen 3-28CTB Meters**

	Make	Model	Size
Total Gas Meter	Cameron NuFlo	Scanner 2000 EFM	2"
Sales Gas Meter	ABB Totalflow Orifice	X6200A	3"

4. **Production Allocation Procedure** - SM Energy Company will use the following procedure to allocate production between the Hagen 3-28HN and Hagen 3-28HS (well information attached) at the Hagen 3-28 Central Tank Battery (CTB#30703-01):

- a. Each well has a dedicated 6' x 20' vertical treater rated to 125 psi, dedicated flowline, dedicated oil tanks, and dedicated water tanks.
 - i. The recycle lines and pump at the CTB will be shared between the three wells (with diverse ownership). Only one tank (production from an individual well) can be recycled at any given time, isolating the line and pump to that specific well.
- b. Oil - Daily volumes will be measured by guided wave radar tank gaugers before being hauled from location by truck.
- c. Gas – Produced gas from each well will separate in the heater treater and will come off of the top of each treater through an orifice plate meter that measures the total gas produced for each well. Gas is then passed through independent ABB TotalFlow orifice meters and on to OneOk's gas gathering system. These meters will be proved per the gather's proving schedule which is once per quarter. If line pressure or other issues prevent gas from being sent to sales, the gas will be sent down a flare line to a Steffes flare. All tank vapors will be sent directly to flare.
- d. Water – Water from each well will be sent to its respective produced water tanks. Water will be measured by guided wave radar tank gaugers and trucked to the nearest Goodnight Midstream SWD.

BEFORE THE INDUSTRIAL COMMISSION

OF THE STATE OF NORTH DAKOTA

Application of SM Energy Company)
pursuant to NDAC §43-02-03-88.1 for an)
order allowing oil and gas produced from the)
Hagen 3-28HN (File No. 30703), Sections 16)
and 21, T.160N., R.99W., and Hagen 3-28HS)
(File No. 30702), Sections 28 and 33,)
T.160N., R.99W., Divide County, ND, wells)
to be commingled in a central production)
facility located in Section 28, T.160N.,)
R.99W., pursuant to NDAC § 43-02-03-48.1)
or granting such other and further relief as)
may be appropriate.)

APPLICATION

RECEIVED

JUN 26 2017

ND Oil & Gas Div.

COMES NOW the applicant, SM Energy Company, and respectfully alleges as follows:

1. It is the owner of an interest in the oil and gas leasehold estate underlying all or portions of Sections 16, 21, 28 and 33, Township 160 North, Range 99 West, Divide County, ND, and is the operator of the Hagen 3-28HN (File No. 30703) and Hagen 3-28HS (File No. 30702) wells which are either drilled, permitted, or in the process of being permitted on spacing units as described above.

2. Section 43-02-03-48.1 of the North Dakota Administrative Code provides that commingling of production from two or more wells having diverse ownership that is not metered prior to commingling may be approved after notice and hearing.

3. Applicant desires to commingle production from said wells in a common production facility and allocate production to the individual wells on the basis of periodic testing through a test facility. Ownership in one or more of the wells commingled in the facility is diverse. In applicant's opinion, such will provide for efficient and economic operation of both wells and thereby maximize production and minimize waste, and will result in reasonably accurate allocation of production, thereby protecting the correlative rights of all parties.

4. Applicant requests that it be allowed to present testimony by telephone pursuant to Section 43-02-03-88.2 of the North Dakota Administrative Code.

WHEREFORE, applicant respectfully requests that this matter be set for hearing at the regularly scheduled hearings in July, 2017 and that thereafter the Commission enter its order granting the relief requested.

Dated this 23rd of June, 2017.

SM ENERGY COMPANY

CROWLEY FLECK PLLP
Attorneys for the Applicant
100 West Broadway, Suite 250
P.O. Box 2798
Bismarck, ND 58502

By: 

JOHN W. MORRISON

STATE OF NORTH DAKOTA)
) ss.
COUNTY OF BURLEIGH)

John W. Morrison, being first duly sworn on oath, deposes and says that he is the attorney for the applicant herein named, that he has read the above and foregoing application, knows the contents thereof, and that the same is true to the best of this affiant's knowledge, information and belief.



JOHN W. MORRISON

Subscribed and sworn to before me this 23rd day of June, 2017.

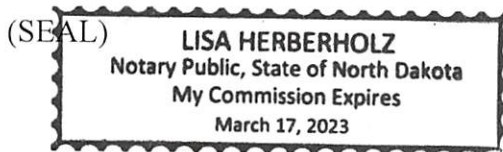

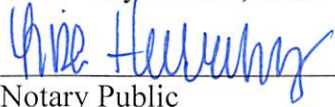

Notary Public
Burleigh County, North Dakota
My Commission Expires: _____



Classified Advertising Invoice

Bismarck Tribune

PO BOX 540
Waterloo, IA 50704-0540
888-418-6474

RECEIVED

JUL 10 2017

ND OIL & GAS DIVISION

OIL & GAS DIVISION

600 E BLVD AVE #405
BISMARCK ND 58505

Customer: 60010203
Phone: (701) 328-8020
Date: 07/03/2017

CREDIT CARD PAYMENT (circle one)



Card #: _____
Exp Date: _____
Signature: _____
Credit card users: Fax to 319-291-4014

PLEASE DETACH AND RETURN TOP PORTION WITH YOUR PAYMENT

Lee Enterprises no longer accepts credit card payments sent via e-mail. Emails containing credit card numbers will be blocked. Please use the coupon above to send a credit card payment to remittance address located in the upper right corner. You may also send the coupon to a secure fax at 319-291-4014.

Date	Date	Times Run	Description	Lines	Class Code	Order Amt	Net Amt Due
07/03/17	07/03/17	1	Bismarck Tribune PO:Hearing Notice	314.00	Legals	509.62	509.62

Affidavit of Publication
 State of North Dakota) SS County of Burleigh
 Before me, a Notary Public for the State of North Dakota
 personally appeared JKL who being duly sworn, deposes
 and says that he (she) is the Clerk of Bismarck Tribune Co.,
 and that the publication(s) were made through the
Bismarck Tribune on the following dates:
7/3 Signed Jill Lindsay
 sworn and subscribed to before me this
 day of July 2017
Morgan Doll
 Notary Public in and for the State of North Dakota

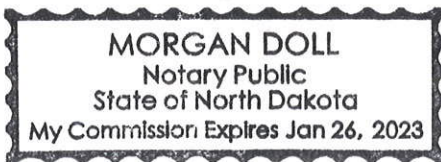

NOTICE OF HEARING
 N.D. INDUSTRIAL COMMISSION
 OIL AND GAS DIVISION
 The North Dakota Industrial Commission will hold a public hearing at 9:00 a.m. Wednesday, July 26, 2017, at the N.D. Oil & Gas Division, 1000 East Calgary Ave., Bismarck, N.D. At the hearing the Commission will receive testimony and exhibits. Persons with any interest in the cases listed below, take notice.
PERSONS WITH DISABILITIES: If at the hearing you need special facilities or assistance, contact the Oil and Gas Division at 701-328-8038 by Thursday, July 13, 2017.
STATE OF NORTH DAKOTA TO:
 Case No. 25929: Proper spacing for the development of the Moord-Tyler Pool, Slope County, ND, redefine the field limits, and enact such special field rules as may be necessary. Marathon Oil
 Case No. 25930: A motion of the Commission to review the temporarily abandoned status of the Berenergy Corp. #12-6 Boyle Well (File No. 5643) located in the NWSW of Section 6, T.163N., R.86W., Pleasant Field, Renville County, ND, pursuant to NDCC § 38-08-04.
 Case No. 25931: Application of Hess Bakken Investments II, LLC, for an order amending the applicable orders for the

Case No. 25932: Application of Petro Harvester Operating Co., LLC, for an order amending the applicable orders for the Portal-Madison Pool to establish two 640-acre spacing units consisting of the W/2 of Sections 2 and 11; and the E/2 of Sections 2 and 11, T.163N., R.92W., Burke County, ND and authorize up to two horizontal wells to be drilled on each such spacing unit with 200 foot setbacks for the toe and heel of each horizontal well, and granting such other and further relief as may be appropriate.
 Case No. 25933: Application of Petro Harvester Operating Co., LLC, for an order amending the applicable orders for the Flaxton-Madison Pool to establish four 400-acre spacing units consisting of the NE/4 of Section 18, the NW/4 and the W/2 NE/4 of Section 17; the SE/4 of Section 18, the SW/4 and the W/2 SE/4 of Section 17; the E/2 NE/4 of Section 17 and the N/2 of Section 16; and the E/2 SE/4 of Section 17 and the S/2 of Section 16, all in T.163N., R.90W., Burke County, ND and authorize up to two horizontal wells to be drilled on each such spacing unit with 200 foot setbacks for the toe and heel of each horizontal well, and granting such other and further relief as may be appropriate.

Capa-Bakken Pool to establish an overlapping 2560-acre spacing unit consisting of Sections 25, 26, 35 and 36, T.155N., R.96W., Williams County, ND, and authorize one horizontal well to be drilled on the unit, and granting such other relief as may be appropriate.

Please return invoice or put order number on check. Thank You.

Remarks _____ Total Due: 509.62

Bismarck Tribune
www.bismarcktribune.com
PO BOX 540
Waterloo, IA 50704-0540

Case No. 25844: (Continued) Application of Petro Harvester Operating Co., LLC, for an order amending the applicable orders for the Portal-Madison Pool to establish three 640-acre spacing units consisting of the SW/4 of Section 3, the W/2 of Section 10 and the NW/4 of Section 15; the NE/4 of Section 15, the N/2 of Section 14 and the NW/4 of Section 13; and the SE/4 of Section 15, the S/2 of Section 14 and the SW/4 of Section 13, all in T.163N., R.92W., Burke County, ND and authorize up to two horizontal wells to be drilled on each such spacing unit with 200 foot setbacks for the toe and heel of each horizontal well, and granting such other and further relief as may be appropriate.

Case No. 25083: (Continued) Proper spacing for the development of the Sheep Butte-Bakken Pool, McKenzie County, ND, redefine the field limits, and enact such special field rules as may be necessary. Petro-Hunt Dakota, LLC, XTO Energy, Inc. Case No. 24929: (Continued) Proper spacing for the development of the Moline-Bakken Pool, McKenzie County, ND, redefine the field limits, and enact such special field rules as may be necessary. Petro-Hunt Dakota, LLC

Case No. 25720: (Continued) Application of Petro-Hunt, LLC, for an order authorizing the flaring of gas from the USA 153-96-24C-13-2H (File No. 28461), USA 153-96-24C-13-3H (File No. 28462), USA 153-96-24C-13-4H (File No. 28463), USA 153-96-24C-13-5H (File No. 28464), and USA 153-96-24D-13-6H (File No. 28465) wells completed in the Keene-Bakken Pool, McKenzie County, ND, for a temporary period of time as an exception to the provisions of Commission Order No. 24665 and such other relief as may be appropriate.

Case No. 25014: (Continued) Proper spacing for the development of the Big Stone-Bakken Pool, Williams County, ND, redefine the field limits, and enact such special field rules as may be necessary. Hess Bakken Investments II, LLC, Whiting Oil and Gas Corp.

Case No. 25934: Application of Whiting Oil and Gas Corp. for an order pursuant to NDAC § 43-02-03-88.1 pooling all interests in a spacing unit described as Sections 13, 14, 23 and 24, T.156N., R.101W., Tyrone-Bakken Pool, Williams County, ND, as provided by NDCC § 38-08-08, and such other relief as is appropriate.

Case No. 25935: Application of Whiting Oil and Gas Corp. for an order pursuant to NDAC § 43-02-03-88.1 pooling all interests in a spacing unit described as Sections 14, 15, 22 and 23, T.156N., R.101W., Tyrone-Bakken Pool, Williams County, ND, as provided by NDCC § 38-08-08, and such other relief as is appropriate.

Case No. 25936: Application of Whiting Oil and Gas Corp. for an order pursuant to NDAC § 43-02-03-88.1 pooling all interests in a spacing unit described as Sections 15, 16, 21 and 22, T.156N., R.101W., Tyrone-Bakken Pool, Williams County, ND, as provided by NDCC § 38-08-08, and such other relief as is appropriate.

Case No. 25937: Application of Whiting Oil and Gas Corp. for an order pursuant to NDAC § 43-02-03-88.1 pooling all interests in a spacing unit described as Sections 25, 26, 35 and 36, T.156N., R.101W., Tyrone-Bakken Pool, Williams County, ND, as provided by NDCC § 38-08-08, and such other relief as is appropriate.

Case No. 25938: Application of Whiting Oil and Gas Corp. for an order pursuant to NDAC § 43-02-03-88.1 pooling all interests in a spacing unit described as Sections 1 and 12, T.156N., R.101W. and Sections 6 and 7, T.156N., R.100W., East Fork-Bakken Pool, Williams County, ND, as provided by NDCC § 38-08-08, and such other relief as is appropriate.

Case No. 25939: Application of Whiting Oil and Gas Corp. for an order pursuant to NDAC § 43-02-03-88.1 pooling all interests in a spacing unit described as Sections 1, 2, 11 and 12, T.156N., R.100W., East Fork-Bakken Pool, Williams County, ND, as provided by NDCC § 38-08-08, and such other relief as is appropriate.

Case No. 25940: Application of Whiting Oil and Gas Corp. for an order pursuant to NDAC § 43-02-03-88.1 pooling all interests in a spacing unit described as Sections 2, 3, 10 and 11, T.156N., R.100W., East Fork-Bakken Pool, Williams County, ND, as provided by NDCC § 38-08-08, and such other relief as is appropriate.

Case No. 25941: Application of Whiting Oil and Gas Corp. for an order pursuant to NDAC § 43-02-03-88.1 pooling all interests in a spacing unit described as Sections 3, 4, 9 and 10, T.156N., R.100W., East Fork-Bakken Pool, Williams County, ND, as provided by NDCC § 38-08-08, and such other relief as is appropriate.

Case No. 25942: Application of Whiting Oil and Gas Corp. for an order pursuant to NDAC § 43-02-03-88.1 pooling all interests in a spacing unit described as Sections 4, 5, 8 and 9, T.156N., R.100W., East Fork-Bakken Pool, Williams County, ND, as provided by NDCC § 38-08-08, and such other relief as is appropriate.

Case No. 25943: Application of Whiting Oil and Gas Corp. for an order pursuant to NDAC § 43-02-03-88.1 pooling all interests in a spacing unit described as Sections 5, 6, 7 and 8, T.156N., R.100W., East Fork-Bakken Pool, Williams County, ND, as provided by NDCC § 38-08-08, and such other relief as is appropriate.

Case No. 25944: Application of Whiting Oil and Gas Corp. for an order pursuant to NDAC § 43-02-03-88.1 pooling all interests in a spacing unit described as Sections 17, 18, 19 and 20, T.156N., R.100W., East Fork-Bakken Pool, Williams County, ND, as provided by NDCC § 38-08-08, and such other relief as is appropriate.

Case No. 25945: Application of Whiting Oil and Gas Corp. for an order pursuant to NDAC § 43-02-03-88.1 pooling all interests in a spacing unit described as the W/2 of Section 11, T.156N., R.100W., East Fork-Madison Pool, Williams County, ND, as provided by NDCC § 38-08-08, and such other relief as is appropriate.

Case No. 25946: Application of Hess Bakken Investments II, LLC, for an order pursuant to NDAC § 43-02-03-88.1 pooling all interests in a spacing unit described as Sections 16, 21, 28 and 33, T.156N., R.98W., Wheelock-Bakken Pool, Williams County, ND, as provided by

NDCC § 38-08-08, and such other relief as is appropriate.

Case No. 25947: Application of Hess Bakken Investments II, LLC, for an order pursuant to NDAC § 43-02-03-88.1 pooling all interests in a spacing unit described as Sections 25, 26, 35 and 36, T.155N., R.96W., Capa-Bakken Pool, Williams County, ND, as provided by NDCC § 38-08-08, and such other relief as is appropriate.

Case No. 25948: Application of Luff Exploration Co. for an order pursuant to NDAC § 43-02-03-88.1 authorizing the conversion to enhanced recovery into the Corey Butte-Red River Unit, of the Paul White #1-35H well (File No. 16093), NESE Section 35, T.129N., R.102W., Corey Butte Field, Bowman County, ND, pursuant to NDAC Chapter 43-02-05 and such other relief as is

Case No. 25856: (Continued) Application of Burlington Resources Oil & Gas Co. LP pursuant to NDAC § 43-02-03-88.1 for an order allowing oil and gas produced from the Mathistad 22A MBH (File No. 33144), Mathistad 22B UTFH (File No. 33146), Mathistad 3NC-MTFH (File No. 33150), Mathistad 6-8-35 MBH (File No. 33152), Croff 22B UTFH (File No. 33145), Croff 22C MBH (File No. 33147), Croff 7-1-2 MBH (File No. 33151), and Croff 6-1-2 UTFH (File No. 33153) wells, Sections 26 and 35, T.150N., R.96W. and Sections 2 and 11, T.149N., R.96W., McKenzie County, ND, to be commingled in a central production facility located in Section 2, T.149N., R.96W., pursuant to NDAC § 43-02-03-88.1 or granting such other and further relief as may be appropriate.

Case No. 25949: Application of SM Energy Co. pursuant to NDAC § 43-02-03-88.1 for an order allowing oil and gas produced from the Pulvermacher 3-10-161-99H 1XN (File No. 24192), Sections 3 and 10, T.161N., R.99W., and Pulvermacher 34-27-162-99H 1XN (File No. 23602), Sections 27 and 34, T.162N., R.99W., Divide County, ND, wells to be commingled in a central production facility located in Section 34, T.162N., R.99W., pursuant to NDAC § 43-02-03-88.1 or granting such other and further relief as may be appropriate.

Case No. 25950: Application of SM Energy Co. pursuant to NDAC § 43-02-03-88.1 for an order allowing oil and gas produced from the Sandvol 22-15-162-98H 3PA (File No. 25003), Sections 15 and 22, T.162N., R.98W., and Sandvol 27-34-162-98H 3XQ (File No. 24776), Sections 27 and 34, T.162N., R.98W., Divide County, ND, wells to be commingled in a central production facility located in Section 22, T.162N., R.98W., pursuant to NDAC § 43-02-03-88.1 or granting such other and further relief as may be appropriate.

Case No. 25951: Application of SM Energy Co. pursuant to NDAC § 43-02-03-88.1 for an order allowing oil and gas produced from the Judith Olson 22-15-162-98H 1XN (File No. 22020), Sections 15 and 22, T.162N., R.98W., and Judith Olson 27-34-162-98H 1XN (File No. 22019), Sections 27 and 34, T.162N., R.98W., Divide County, ND, wells to be commingled in a central production facility located in Section 22, T.162N., R.98W., pursuant to NDAC § 43-02-03-88.1 or granting such other and further relief as may be appropriate.

Case No. 25952: Application of SM Energy Co. pursuant to NDAC § 43-02-03-88.1 for an order allowing oil and gas produced from the J. Olson 22-15-162-98H 2DM (File No. 24999), Sections 15 and 22, T.162N., R.98W., and J. Olson 27-34-162-98H 2XM (File No. 24690), Sections 27 and 34, T.162N., R.98W., Divide County, ND, wells to be commingled in a central production facility located in Section 22, T.162N., R.98W., pursuant to NDAC § 43-02-03-88.1 or granting such other and further relief as may be appropriate.

Case No. 25953: Application of SM Energy Co. pursuant to NDAC § 43-02-03-88.1 for an order allowing oil and gas produced from the Burton Olson 21-16-162-98H 1PB (File No. 23410), Sections 16 and 21, T.162N., R.98W., and Burton Olson 28-33-162-98H 1XP (File No. 23409), Sections 28 and 33, T.162N., R.98W., Divide County, ND, wells to be commingled in a central production facility located in Section 21, T.162N., R.98W., pursuant to NDAC § 43-02-03-88.1 or granting such other and further relief as may be appropriate.

Case No. 25954: Application of SM Energy Co. pursuant to NDAC § 43-02-03-88.1 for an order allowing oil and gas produced from the Wendi 16-21HS (File No. 27321), Sections 28 and 33, T.162N., R.98W., and Chanda 16-21HS (File No. 27324), Sections 16 and 21, T.162N., R.98W., Divide County, ND, wells to be commingled in a central production facility located in Section 21, T.162N., R.98W., pursuant to NDAC § 43-02-03-88.1 or granting such other and further relief as may be appropriate.

Case No. 25955: Application of SM Energy Co. pursuant to NDAC § 43-02-03-88.1 for an order allowing oil and gas produced from the Orville 29-32-162-98H 2XM (File No. 28229), Sections 29 and 32, T.162N., R.98W., Arlene 30-31-162-98H 2XQ (File No. 28230), Sections 30 and 31, T.162N., R.98W., and Overland 20-17-162-98H 4MD (File No. 28228), Sections 17 and 20, T.162N., R.98W., Divide County, ND, wells to be commingled in a central production facility located in Section 20, T.162N., R.98W., pursuant to NDAC § 43-02-03-88.1 or granting such other and further relief as may be appropriate.

Case No. 25956: Application of SM Energy Co. pursuant to NDAC § 43-02-03-88.1 for an order allowing oil and gas produced from the Marilyn Nelson 20-17-162-98H 1XB (File No. 23407), Bernie A-20-17-162-98H 2XC (File No. 27620), and Bernie B-20-17-162-98H 3XB (File No. 27621), Sections 17 and 20, T.162N., R.98W., and Marilyn Nelson 29-32-162-98H 1BP (File No. 23240), Sections 29 and 32, T.162N., R.98W., Divide County, ND, wells to be commingled in a central production facility located in Section 29, T.162N., R.98W., pursuant to NDAC § 43-02-03-88.1 or granting such other and further relief as may be appropriate.

Case No. 25957: Application of SM Energy Co. pursuant to NDAC § 43-02-03-88.1 for an order allowing oil and gas produced from the Ebreck 33-28-162-97H 1XN (File No. 24029), Sections 28 and 33, T.162N., R.97W., and Ebreck 4-9-161-97H 1XN (File No. 24353), Sections 4 and 9, T.161N., R.97W., Divide County, ND, wells to be commingled in a central production facility located in Section 33, T.162N., R.97W., pursuant to NDAC § 43-02-03-88.1 or granting such other and further relief as may be appropriate.

Case No. 25958: Application of SM Energy Co. pursuant to NDAC § 43-02-03-88.1 for an order allowing oil and gas produced from the Leo 32-29-162-97H 1XN (File No. 23911), Sections 29 and 32, T.162N., R.97W., and Leo 5-8-161-97H 1XN (File No. 24216), Sections 5 and 8, T.161N., R.97W., Divide County, ND, wells to be commingled in a central production facility located in Section 32, T.162N., R.97W., pursuant to NDAC § 43-02-03-88.1 or granting such other and further relief as may be appropriate.

Case No. 25959: Application of SM Energy Co. pursuant to NDAC § 43-02-03-88.1 for an order allowing oil and gas produced from the Marjorie 31-30-162-97H 1PB (File No. 22782), Sections 30 and 31, T.162N., R.97W., and Marjorie 6-7-161-97H 1XP (File No. 22781), Sections 6 and 7, T.161N., R.97W., Divide County, ND, wells to be commingled in a central production facility located in Section 31, T.162N., R.97W., pursuant to NDAC § 43-02-03-88.1 or granting such other and further relief as may be appropriate.

Case No. 25960: Application of SM Energy Co. pursuant to NDAC § 43-02-03-88.1 for an order allowing oil and gas produced from the Karlberg 14-12HS (File No.

29738), Sections 1 and 12, T.161N., R.99W., and Karlberg 14-12HS (File No. 29739), Sections 13 and 24, T.161N., R.99W., Divide County, ND, wells to be commingled in a central production facility located in Section 12, T.161N., R.99W., pursuant to NDAC § 43-02-03-88.1 or granting such other and further relief as may be appropriate.

Case No. 25961: Application of SM Energy Co. pursuant to NDAC § 43-02-03-88.1 for an order allowing oil and gas produced from the Thompson 2-11-161-99H 1BP (File No. 21849), Sections 2 and 11, T.161N., R.99W., and Thompson 35-26-162-99H 1XB (File No. 21850), Sections 26 and 35, T.162N., R.99W., Divide County, ND, wells to be commingled in a central production facility located in Section 2, T.161N., R.99W., pursuant to NDAC § 43-02-03-88.1 or granting such other and further relief as may be appropriate.

Case No. 25962: Application of SM Energy Co. pursuant to NDAC § 43-02-03-88.1 for an order allowing oil and gas produced from the Burtman 14-23HS (File No. 31305), Sections 14 and 23, T.161N., R.99W., and Burtman 14-23HS (File No. 31306), Sections 26 and 35, T.161N., R.99W., Divide County, ND, wells to be commingled in a central production facility located in Section 23, T.161N., R.99W., pursuant to NDAC § 43-02-03-88.1 or granting such other and further relief as may be appropriate.

Case No. 25963: Application of SM Energy Co. pursuant to NDAC § 43-02-03-88.1 for an order allowing oil and gas produced from the Mo Farms 15-21HN (File No. 31680), Sections 16 and 21, T.161N., R.99W., and Mo Farms 15-21HS (File No. 31679), Sections 28 and 33, T.161N., R.99W., Divide County, ND, wells to be commingled in a central production facility located in Section 21, T.161N., R.99W., pursuant to NDAC § 43-02-03-48.1 or granting such other and further relief as may be appropriate.

Case No. 25964: Application of SM Energy Co. pursuant to NDAC § 43-02-03-88.1 for an order allowing oil and gas produced from the Dohmstreich 15-20HS (File No. 29623), Sections 29 and 32, T.161N., R.99W., and Dohmstreich 15B-20HN (File No. 29624), Sections 17 and 20, T.161N., R.99W., Divide County, ND, wells to be commingled in a central production facility located in Section 20, T.161N., R.99W., pursuant to NDAC § 43-02-03-48.1 or granting such other and further relief as may be appropriate.

Case No. 25965: Application of SM Energy Co. pursuant to NDAC § 43-02-03-88.1 for an order allowing oil and gas produced from the Molander 22-15-161-99H IXC (File No. 26776), Sections 15 and 22, T.161N., R.99W., and Molander 27-34-161-99H IXC (File No. 26775), Sections 27 and 34, T.161N., R.99W., Divide County, ND, wells to be commingled in a central production facility located in Section 27, T.161N., R.99W., pursuant to NDAC § 43-02-03-48.1 or granting such other and further relief as may be appropriate.

Case No. 25966: Application of SM Energy Co. pursuant to NDAC § 43-02-03-88.1 for an order allowing oil and gas produced from the Marcella 1-12-161-98H 2DM (File No. 25016), Sections 1 and 12, T.161N., R.98W., and Marcella 36-25-162-98H 2XD (File No. 24691), Sections 25 and 36, T.162N., R.98W., Divide County, ND, wells to be commingled in a central production facility located in Section 1, T.161N., R.98W., pursuant to NDAC § 43-02-03-48.1 or granting such other and further relief as may be appropriate.

Case No. 25967: Application of SM Energy Co. pursuant to NDAC § 43-02-03-88.1 for an order allowing oil and gas produced from the Lokken 1-12-161-98H 1BP (File No. 21910), Sections 1 and 12, T.161N., R.98W., and Lokken 36-25-162-98H 1XB (File No. 21911), Sections 25 and 36, T.162N., R.98W., Divide County, ND, wells to be commingled in a central production facility located in Section 1, T.161N., R.98W., pursuant to NDAC § 43-02-03-48.1 or granting such other and further relief as may be appropriate.

Case No. 25968: Application of SM Energy Co. pursuant to NDAC § 43-02-03-88.1 for an order allowing oil and gas produced from the Nelson 18-19-161-98H 1BP (File No. 26087), Sections 18 and 19, T.161N., R.98W., and Nelson 7-6-161-98H 1XB (File No. 26088), Sections 6 and 7, T.161N., R.98W., Divide County, ND, wells to be commingled in a central production facility located in Section 18, T.161N., R.98W., pursuant to NDAC § 43-02-03-48.1 or granting such other and further relief as may be appropriate.

Case No. 25969: Application of SM Energy Co. pursuant to NDAC § 43-02-03-88.1 for an order allowing oil and gas produced from the Nystuen 14-35HN (File No. 32335), Sections 26 and 35, T.161N., R.98W., and Nystuen 14B-35HS (File No. 32336), Sections 5 and 8, T.160N., R.98W., Divide County, ND, wells to be commingled in a central production facility located in Section 35, T.161N., R.98W., pursuant to NDAC § 43-02-03-48.1 or granting such other and further relief as may be appropriate.

Case No. 25970: Application of SM Energy Co. pursuant to NDAC § 43-02-03-88.1 for an order allowing oil and gas produced from the Bentson 24-13-161-98H 1XB (File No. 22124), Sections 13 and 24, T.161N., R.98W., and Bentson 25-36-161-98H 1AP (File No. 21948), Sections 25 and 36, T.161N., R.98W., Divide County, ND, wells to be commingled in a central production facility located in Section 25, T.161N., R.98W., pursuant to NDAC § 43-02-03-48.1 or granting such other and further relief as may be appropriate.

Case No. 25971: Application of SM Energy Co. pursuant to NDAC § 43-02-03-88.1 for an order allowing oil and gas produced from the Bissonnette 14B-31HN (File No. 31728), Sections 30 and 31, T.161N., R.97W., and Bissonnette 14B-31HS (File No. 31729), Sections 3 and 10, T.160N., R.98W., Divide County, ND, wells to be commingled in a central production facility located in Section 31, T.161N., R.97W., pursuant to NDAC § 43-02-03-48.1 or granting such other and further relief as may be appropriate.

Case No. 25972: Application of SM Energy Co. pursuant to NDAC § 43-02-03-88.1 for an order allowing oil and gas produced from the Russell 2B-4HS (File No. 32557), Sections 4 and 9, T.160N., R.99W., and Martin 2-4HN (File No. 32558), Sections 25 and 36, T.161N., R.99W., Divide County, ND, wells to be commingled in a central production facility located in Section 4, T.160N., R.99W., pursuant to NDAC § 43-02-03-48.1 or granting such other and further relief as may be appropriate.

Case No. 25973: Application of SM Energy Co. pursuant to NDAC § 43-02-03-88.1 for an order allowing oil and gas produced from the Hagen 3-28HN (File No. 30703), Sections 16 and 21, T.160N., R.99W., and Hagen 3-28HS (File No. 30702), Sections 28 and 33, T.160N., R.99W., Divide County, ND, wells to be commingled in a central production facility located in Section 28, T.160N., R.99W., pursuant to NDAC § 43-02-03-48.1 or granting such other and further relief as may be appropriate.

Case No. 25974: Application of SM Energy Co. pursuant to NDAC § 43-02-03-88.1 for an order allowing oil and gas produced from the Bronkar 2-6HN (File No. 32433), Sections 27 and 34, T.161N., R.98W., and Bronkar 2B-6HS (File No. 32432), Sections 6 and 7, T.160N., R.98W., Divide County, ND, wells to be commingled in a central production facility located in Section 6, T.160N., R.98W., pursuant to NDAC § 43-02-03-48.1 or granting such other and further relief as may be appropriate.

Continue on Page 6A

Continue from Page 4A

Case No. 25975: Application of SM Energy Co. pursuant to NDAC § 43-02-03-88.1 for an order allowing oil and gas produced from the Redfield 14-23-157-99H (File No. 19787) and the Redfield 14-23 2H (File No. 23142), Sections 14 and 23, T.157N., R.99W., the Redfield 24-13-157-99H INC (File No. 21781), Sections 13 and 24, T.157N., R.99W., and the Redfield 25-36-157-99H (File No. 19133), Sections 25 and 36, T.157N., R.99W., Williams County, ND, wells to be commingled in a central production facility located in Section 23, T.157N., R.99W., pursuant to NDAC § 43-02-03-48.1 or granting such other and further relief as may be appropriate.

Signed by,
Doug Burgum, Governor
Chairman, NDIC
7/3 - 20899765

RECEIVED
JUL 14 2017
ND Oil & Gas Div.

Affidavit of Publication

Colleen Park, being duly sworn, states as follows:

1. I am the designated agent, under the provisions and for the purposes of, Section 31-04-06, NDCC, for the newspapers listed on the attached exhibits.
2. The newspapers listed on the exhibits published the advertisement of: **Oil and Gas Division – beginning with Case No. 25949, The Journal, Crosby; 1 time(s)** as required by law or ordinance.
3. All of the listed newspapers are legal newspapers in the State of North Dakota and, under the provisions of Section 46-05-01, NDCC, are qualified to publish any public notice or any matter required by law or ordinance to be printed or published in a newspaper in North Dakota.

Signed: Colleen Park

State of North Dakota

County of Burleigh

Subscribed and sworn to before me this 13 day of July, 20 17.

Sharon L. Peterson

SHARON L. PETERSON
Notary Public
State of North Dakota
My Commission Expires Nov. 8, 2017

**NOTICE OF HEARING
N.D. INDUSTRIAL COMMISSION
OIL AND GAS DIVISION**

The North Dakota Industrial Commission will hold a public hearing at 9:00 a.m. Wednesday, July 26, 2017, at the N.D. Oil & Gas Division, 1000 East Calgary Ave., Bismarck, N. D. At the hearing the Commission will receive testimony and exhibits. Persons with any interest in the cases listed below, take notice.

PERSONS WITH DISABILITIES: If at the hearing you need special facilities or assistance, contact the Oil and Gas Division at 701-328-8038 by Thursday, July 13, 2017.

STATE OF NORTH DAKOTA TO: Case No. 25949: Application of SM Energy Co. pursuant to NDAC § 43-02-03-88.1 for an order allowing oil and gas produced from the Pulvermacher 3-10-161-99H 1XN (File No. 24192), Sections 3 and 10, T.161N., R.99W., and Pulvermacher 34-27-162-99H 1NC (File No. 23602), Sections 27 and 34, T.162N., R.99W., Divide County, ND, wells to be commingled in a central production facility located in Section 34, T.162N., R.99W., pursuant to NDAC § 43-02-03-48.1 or granting such other and further relief as may be appropriate.

Case No. 25950: Application of SM Energy Co. pursuant to NDAC § 43-02-03-88.1 for an order allowing oil and gas produced from the Sandvol 22-15-162-98H 3PA (File No. 25003), Sections 15 and 22, T.162N., R.98W., and Sandvol 27-34-162-98H 3XQ (File No. 24776), Sections 27 and 34, T.162N., R.98W., Divide County, ND, wells to be commingled in a central production facility located in Section 22, T.162N., R.98W., pursuant to NDAC § 43-02-03-48.1 or granting such other and further relief as may be appropriate.

Case No. 25951: Application of SM Energy Co. pursuant to NDAC § 43-02-03-88.1 for an order allowing oil and gas produced from the Judith Olson 22-15-162-98H 1NC (File No. 22020), Sections 15 and 22, T.162N., R.98W., and Judith Olson 27-34-162-98H 1XN (File No. 22019), Sections 27 and 34, T.162N., R.98W., Divide County, ND, wells to be commingled in a central production facility located in Section 22, T.162N., R.98W., pursuant to NDAC § 43-02-03-48.1 or granting such other and further relief as may be appropriate.

Case No. 25952: Application of SM Energy Co. pursuant to NDAC § 43-02-03-88.1 for an order allowing oil and gas produced from the J. Olson 22-15-162-98H 2DM (File No. 24999), Sections 15 and 22,

T.162N., R.98W., and J. Olson 27-34-162-98H 2XM (File No. 24690), Sections 27 and 34, T.162N., R.98W., Divide County, ND, wells to be commingled in a central production facility located in Section 22, T.162N., R.98W., pursuant to NDAC § 43-02-03-48.1 or granting such other and further relief as may be appropriate.

Case No. 25953: Application of SM Energy Co. pursuant to NDAC § 43-02-03-88.1 for an order allowing oil and gas produced from the Burton Olson 21-16-162-98H 1PB (File No. 23410), Sections 16 and 21, T.162N., R.98W., and Burton Olson 28-33-162-98H 1XP (File No. 23409), Sections 28 and 33, T.162N., R.98W., Divide County, ND, wells to be commingled in a central production facility located in Section 21, T.162N., R.98W., pursuant to NDAC § 43-02-03-48.1 or granting such other and further relief as may be appropriate.

Case No. 25954: Application of SM Energy Co. pursuant to NDAC § 43-02-03-88.1 for an order allowing oil and gas produced from the Wendi 16-21HS (File No. 27321), Sections 28 and 33, T.162N., R.98W., and Chanda 16-21HN (File No. 27324), Sections 16 and 21, T.162N., R.98W., Divide County, ND, wells to be commingled in a central production facility located in Section 21, T.162N., R.98W., pursuant to NDAC § 43-02-03-48.1 or granting such other and further relief as may be appropriate.

Case No. 25955: Application of SM Energy Co. pursuant to NDAC § 43-02-03-88.1 for an order allowing oil and gas produced from the Orville 29-32-162-98H 2XM (File No. 28229), Sections 29 and 32, T.162N., R.98W., Arlene 30-31-162-98H 2XQ (File No. 28230), Sections 30 and 31, T.162N., R.98W., and Overland 20-17-162-98H 4MD (File No. 28228), Sections 17 and 20, T.162N., R.98W., Divide County, ND, wells to be commingled in a central production facility located in Section 20, T.162N., R.98W., pursuant to NDAC § 43-02-03-48.1 or granting such other and further relief as may be appropriate.

Case No. 25956: Application of SM Energy Co. pursuant to NDAC § 43-02-03-88.1 for an order allowing oil and gas produced from the Marilyn Nelson 20-17-162-98H 1XB (File No. 23407), Bernie A-20-17-162-98H 2XC (File No. 27620), and Bernie B-20-17-162-98H 3XB (File No. 27621), Sections 17 and 20, T.162N., R.98W., and Marilyn Nelson 29-32-162-98H 1BP (File No. 23240), Sections 29 and 32, T.162N., R.98W., Divide County, ND, wells to be commingled in a

central production facility located in Section 29, T.162N., R.98W., pursuant to NDAC § 43-02-03-48.1 or granting such other and further relief as may be appropriate.

Case No. 25957: Application of SM Energy Co. pursuant to NDAC § 43-02-03-88.1 for an order allowing oil and gas produced from the Ebreck 33-28-162-97H 1NC (File No. 24029), Sections 28 and 33, T.162N., R.97W., and Ebreck 4-9-161-97H 1XN (File No. 24353), Sections 4 and 9, T.161N., R.97W., Divide County, ND, wells to be commingled in a central production facility located in Section 33, T.162N., R.97W., pursuant to NDAC § 43-02-03-48.1 or granting such other and further relief as may be appropriate.

Case No. 25958: Application of SM Energy Co. pursuant to NDAC § 43-02-03-88.1 for an order allowing oil and gas produced from the Leo 32-29-162-97H 1NC (File No. 23911), Sections 29 and 32, T.162N., R.97W., and Leo 5-8-161-97H 1XN (File No. 24216), Sections 5 and 8, T.161N., R.97W., Divide County, ND, wells to be commingled in a central production facility located in Section 32, T.162N., R.97W., pursuant to NDAC § 43-02-03-48.1 or granting such other and further relief as may be appropriate.

Case No. 25959: Application of SM Energy Co. pursuant to NDAC § 43-02-03-88.1 for an order allowing oil and gas produced from the Marjorie 31-30-162-97H 1PB (File No. 22782), Sections 30 and 31, T.162N., R.97W., and Marjorie 6-7-161-97H 1XP (File No. 22781), Sections 6 and 7, T.161N., R.97W., Divide County, ND, wells to be commingled in a central production facility located in Section 31, T.162N., R.97W., pursuant to NDAC § 43-02-03-48.1 or granting such other and further relief as may be appropriate.

Case No. 25960: Application of SM Energy Co. pursuant to NDAC § 43-02-03-88.1 for an order allowing oil and gas produced from the Karlberg 14-12HN (File No. 29738), Sections 1 and 12, T.161N., R.99W., and Karlberg 14-12HS (File No. 29739), Sections 13 and 24, T.161N., R.99W., Divide County, ND, wells to be commingled in a central production facility located in Section 12, T.161N., R.99W., pursuant to NDAC § 43-02-03-48.1 or granting such other and further relief as may be appropriate.

Case No. 25961: Application of SM Energy Co. pursuant to NDAC § 43-02-03-88.1 for an order allowing oil and gas produced from the Thompson 2-11-161-99H 1BP (File No. 21849), Sections 2 and 11, T.161N.,

R.99W., and Thompson 35-26-162-99H 1XB (File No. 21850), Sections 26 and 35, T.162N., R.99W., Divide County, ND, wells to be commingled in a central production facility located in Section 2, T.161N., R.99W., pursuant to NDAC § 43-02-03-48.1 or granting such other and further relief as may be appropriate.

Case No. 25962: Application of SM Energy Co. pursuant to NDAC § 43-02-03-88.1 for an order allowing oil and gas produced from the Burtman 14-23HN (File No. 31305), Sections 14 and 23, T.161N., R.99W., and Burtman 14-23HS (File No. 31306), Sections 26 and 35, T.161N., R.99W., Divide County, ND, wells to be commingled in a central production facility located in Section 23, T.161N., R.99W., pursuant to NDAC § 43-02-03-48.1 or granting such other and further relief as may be appropriate.

Case No. 25963: Application of SM Energy Co. pursuant to NDAC § 43-02-03-88.1 for an order allowing oil and gas produced from the Mo Farms 15-21HN (File No. 31680), Sections 16 and 21, T.161N., R.99W., and Mo Farms 15-21HS (File No. 31679), Sections 28 and 33, T.161N., R.99W., Divide County, ND, wells to be commingled in a central production facility located in Section 21, T.161N., R.99W., pursuant to NDAC § 43-02-03-48.1 or granting such other and further relief as may be appropriate.

Case No. 25964: Application of SM Energy Co. pursuant to NDAC § 43-02-03-88.1 for an order allowing oil and gas produced from the Dohmstrieck 15-20HS (File No. 29623), Sections 29 and 32, T.161N., R.99W., and Dohmstrieck 15B-20HN (File No. 29624), Sections 17 and 20, T.161N., R.99W., Divide County, ND, wells to be commingled in a central production facility located in Section 20, T.161N., R.99W., pursuant to NDAC § 43-02-03-48.1 or granting such other and further relief as may be appropriate.

Case No. 25965: Application of SM Energy Co. pursuant to NDAC § 43-02-03-88.1 for an order allowing oil and gas produced from the Molander 22-15-161-99H 1XC (File No. 26776), Sections 15 and 22, T.161N., R.99W., and Molander 27-34-161-99H 1CN (File No. 26775), Sections 27 and 34, T.161N., R.99W., Divide County, ND, wells to be commingled in a central production facility located in Section 27, T.161N., R.99W., pursuant to NDAC § 43-02-03-48.1 or granting such other and further relief as may be appropriate.

Case No. 25966: Application of SM

Energy Co. pursuant to NDAC § 43-02-03-88.1 for an order allowing oil and gas produced from the Marcella 1-12-161-98H 2DM (File No. 25016), Sections 1 and 12, T.161N., R.98W., and Marcella 36-25-162-98H 2XD (File No. 24691), Sections 25 and 36, T.162N., R.98W., Divide County, ND, wells to be commingled in a central production facility located in Section 1, T.161N., R.98W., pursuant to NDAC § 43-02-03-48.1 or granting such other and further relief as may be appropriate.

Case No. 25967: Application of SM Energy Co. pursuant to NDAC § 43-02-03-88.1 for an order allowing oil and gas produced from the Lokken 1-12-161-98H 1BP (File No. 21910), Sections 1 and 12, T.161N., R.98W., and Lokken 36-25-162-98H 1XB (File No. 21911), Sections 25 and 36, T.162N., R.98W., Divide County, ND, wells to be commingled in a central production facility located in Section 1, T.161N., R.98W., pursuant to NDAC § 43-02-03-48.1 or granting such other and further relief as may be appropriate.

Case No. 25968: Application of SM Energy Co. pursuant to NDAC § 43-02-03-88.1 for an order allowing oil and gas produced from the Nelson 18-19-161-98H 1BP (File No. 26087), Sections 18 and 19, T.161N., R.98W., and Nelson 7-6-161-98H 1XB (File No. 26088), Sections 6 and 7, T.161N., R.98W., Divide County, ND, wells to be commingled in a central production facility located in Section 18, T.161N., R.98W., pursuant to NDAC § 43-02-03-48.1 or granting such other and further relief as may be appropriate.

Case No. 25969: Application of SM Energy Co. pursuant to NDAC § 43-02-03-88.1 for an order allowing oil and gas produced from the Nystuen 14-35HN (File No. 32335), Sections 26 and 35, T.161N., R.98W., and Nystuen 14B-35HS (File No. 32336), Sections 5 and 8, T.160N., R.98W., Divide County, ND, wells to be commingled in a central production facility located in Section 35, T.161N., R.98W., pursuant to NDAC § 43-02-03-48.1 or granting such other and further relief as may be appropriate.

Case No. 25970: Application of SM Energy Co. pursuant to NDAC § 43-02-03-88.1 for an order allowing oil and gas produced from the Bentson 24-13-161-98H 1XB (File No. 22124), Sections 13 and 24, T.161N., R.98W., and Bentson 25-36-161-98H 1AP (File No. 21948), Sections 25 and 36, T.161N., R.98W., Divide County, ND, wells to be commingled in a central production facility located in Section

25, T.161N., R.98W., pursuant to NDAC § 43-02-03-48.1 or granting such other and further relief as may be appropriate.

Case No. 25971: Application of SM Energy Co. pursuant to NDAC § 43-02-03-88.1 for an order allowing oil and gas produced from the Bissonnette 14B-31HN (File No. 31728), Sections 30 and 31, T.161N., R.97W., and Bissonnette 14B-31HS (File No. 31729), Sections 3 and 10, T.160N., R.98W., Divide County, ND, wells to be commingled in a central production facility located in Section 31, T.161N., R.97W., pursuant to NDAC § 43-02-03-48.1 or granting such other and further relief as may be appropriate.

Case No. 25972: Application of SM Energy Co. pursuant to NDAC § 43-02-03-88.1 for an order allowing oil and gas produced from the Russell 2B-4HS (File No. 32557), Sections 4 and 9, T.160N., R.99W., and Martin 2-4HN (File No. 32558), Sections 25 and 36, T.161N., R.99W., Divide County, ND, wells to be commingled in a central production facility located in Section 4, T.160N., R.99W., pursuant to NDAC § 43-02-03-48.1 or granting such other and further relief as may be appropriate.

Case No. 25973: Application of SM Energy Co. pursuant to NDAC § 43-02-03-88.1 for an order allowing oil and gas produced from the Hagen 3-28HN (File No. 30703), Sections 16 and 21, T.160N., R.99W., and Hagen 3-28HS (File No. 30702), Sections 28 and 33, T.160N., R.99W., Divide County, ND, wells to be commingled in a central production facility located in Section 28, T.160N., R.99W., pursuant to NDAC § 43-02-03-48.1 or granting such other and further relief as may be appropriate.

Case No. 25974: Application of SM Energy Co. pursuant to NDAC § 43-02-03-88.1 for an order allowing oil and gas produced from the Bronkar 2-6HN (File No. 32433), Sections 27 and 34, T.161N., R.98W., and Bronkar 2B-6HS (File No. 32432), Sections 6 and 7, T.160N., R.98W., Divide County, ND, wells to be commingled in a central production facility located in Section 6, T.160N., R.98W., pursuant to NDAC § 43-02-03-48.1 or granting such other and further relief as may be appropriate.

Signed by,
Doug Burgum, Governor
Chairman, NDIC

(7/5)